	Technical Guide		TG-19-C-006-E	D
	Produced by : pelrom	Date: 09.10.2008	3	

CALIBRE 2628

	Version A	Version B
$11\frac{1}{2}'''$ Ø 25,60 mm		
Height on movement	5.20 mm	
Power reserve	44 h	48 h
Number of jewels	27	27
Frequency	4 Hz (28'800 A/h)	3.5 Hz (25'200 A/h)
Lift angle	30° / 38°	38°

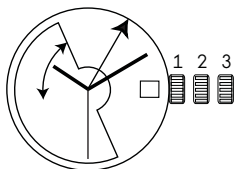

Automatic movement, Co-Axial escapement, date, Time zone function, GMT, COSC-certified, Omega balance system without index. GMT, hour, minute and second hands in centre.

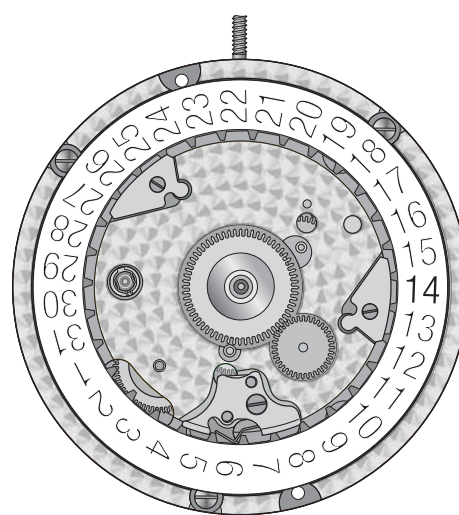
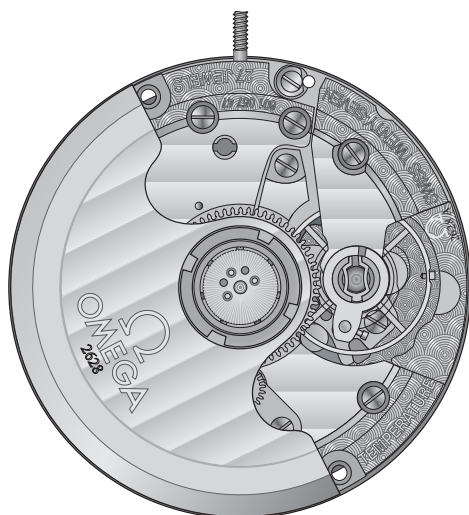

	Page
Calibre 2628	1
General information for Calibre 2628	3-4
Date correction / Improvements on version B / Complete balance bridge	3
Torques according to the screw threads / Measuring instruments	3
Technical modifications on version «A» and «B» / Hand fitting / Tools / Lubricants	4
Differences between calibre 2628A and 2628B	5-6
Differences between calibres	5-6
Exploded views for Calibre 2628	7-11
Dial side	7
Movement side	8
Movement side	9
Dial side	10
Spare parts list for Calibre 2628	11-14
Spare parts list	11
Spare parts list	12
Spare parts list	13
Spare parts list	14
Specific information for Calibre 2628	15-19
Assembling of escapement system / Lubrication of the escapement	15
Assembling of the balance bridge / Disassembling of the balance bridge	16
Runners for hands setting and hand setting force / Height of hands	17
Components not requiring epilam coating	18
Special parameter settings / Timing key	19



General information for Calibre 2628

Date correction

The date Correction is not recommended between 10 p.m. and 2 a.m.

Version A	Version B
Quality of adjustment: Good	Quality of adjustment: Improved
Self-starting: Medium	Self-starting: Good

Improvements on version B

Complete balance bridge (Ref. 10.058°)

Chronometer balance bridges are not available (see CS-Info. Calibre No. 33).

Tightening and untightening torques according to screw thread size



Screw Ø	Tightening torque target cNm	Untightening torque mini cNm
Ø threads ≤ S 0.50 mm	1.0	0.7
Ø threads S 0.6 mm	1.4	0.8
Ø threads S 0.7 mm	1.8	0.9
Ø threads S 0.8 mm	2.2	1.1
Ø threads S 0.9 mm	2.6	1.3
Ø threads S 1.0 mm	3.0	1.6
Ø threads S 1.2 mm	3.5	2.0
Ø threads S 1.4 and >	4.0	2.5

Type of intervention and the required «Measure Instrument»

Interventions	Minimum equipment required	Comments
Complete or Partial maintenance service Co-Axial 3.5 Hz & 4 Hz	- Watch Expert II (White case) - Chronoscope M1 (up-dated version) - Chronoscope S1	
Rate adjustment on new watches: (Co-Axial 3.5 Hz & 4 Hz)	- Watch Expert (red case) - Wicometer Professionnel - Chronoscope M1 (old version)	Important: The amplitude will not be indicated precisely. This is acceptable for the rate adjustment only!



Technical modifications on version «A» and «B»

Intermediate escape wheel				
Old version	Risk	New version	Improvements	Notes
7222500C30039		7222500C30039		
	Black residues within the engagement can cause low amplitude or a stop of the watch. The old version is yellow.		Improvement of surface and material. The new version is grey. Available since 21/2008	The new version must automatically be assembled if black residues within the engagement are visible.

Hand fitting

To fit the hands, the movement must be placed in a suitable, well-adjusted movement holder.

Tools

Hand fitting tool kit
 Movement holder for hand fitting
 Mainspring winder
 Timing key
 Tool for checking the escapement functions
 Ball bearing set
 Key-bolt key for oscillating weight
 Holder for oscillating weight

Ref.

507 0011
 507 0017
 502 150 0009
 506 0042
 506 0002
 502 S03 SET
 502 200 0361
 502 100 0381

Lubricants











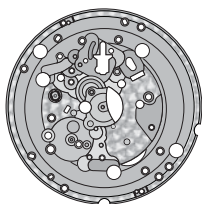
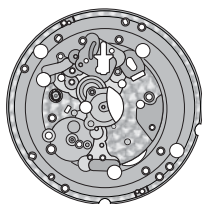

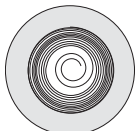
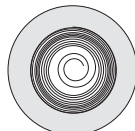

Moebius SYNT-A-LUBE 9010 (2ml)
 Moebius HP-500
 Moebius SYNT HP-1300 Sans Colorant
 Moebius 9504
 Kluber P125
 Lubeta V105

Ref.

















504 200 0001
 504 5012
 504 5013
 504 5014
 504 100 0071
 504 5005



Differences between versions 2628A and 2628B

	2628A (4 Hz)	2628B (3.5 Hz)
Mainplate	 ref. 72226281002007 Engraving 2628A	 ref. 7222628B81002007 Engraving 2628B
Balance bridge	 ref. 7222500B10058°	 ref. 7222500C10058°
Barrel, complete	 ref. 7222500B20010	 ref. 722112020010
Mainspring	 ref. 7222500B20102	 ref. 722112020102
Oscillating weight	 ref. 72226282201006	 ref. 7222628B2201006
Second wheel	 ref. 722112830027* 96 teeth and eight arms	 ref. 7222628B30027* 105 teeth and five arms
Intermediate escape wheel	 ref. 7222500B30039 8-leaf pinion	 ref. 7222500C30039 10-leaf pinion Cutout in upper pivot shank
Co-Axial wheel	 ref. 7222500B30040 Pinion Ø = 1.999 mm	 ref. 7222500C30040 Pinion Ø = 2.119 mm
Pallet fork	 Old shape ref. 7222500B40010	 New shape ref. 7222500C40010



Differences between versions 2628A and 2628B

	2628A (4 Hz)	2628B (3.5 Hz)
Balance complete with stud		
Inertia	ref. 7222500B4005021 7.2 (mgcm ²)	ref. 7222500C4005021 9.4 (mgcm ²)
Diameter	8.54 mm	8.70 mm
Balance rim thickness	0.37 mm	0.45 mm
Pivots	0.08 mm cylindrical	0.07 mm conical
Shock absorber	0.09 mm = pivot hole Ø	0.08 mm = pivot hole Ø
Rate correction with 1 screw-revolution (on both screws)	57 seconds	86 seconds
Stop lever	 ref. 722250056070	 ref. 7222500C56070
Shock-absorber, upper	  ref. 722112070530	  ref. 7222500C70530
Shock-absorber, lower	  ref. 722112070531	  ref. 7222500C70531
In settings, upper	 ref. 722112070640	 ref. 7222500C70640
In settings, lower	 ref. 722112070641	 ref. 7222500C70641

Exploded views - Dial side for Calibre 2628

Parts listed in order of assembly

1 = 31120	6 = 51050
2 = 31121	7 = 51091
3 = 5101021	8 = 3503 (1x)
4 = 53022	9 = 31100
5 = 5108006	



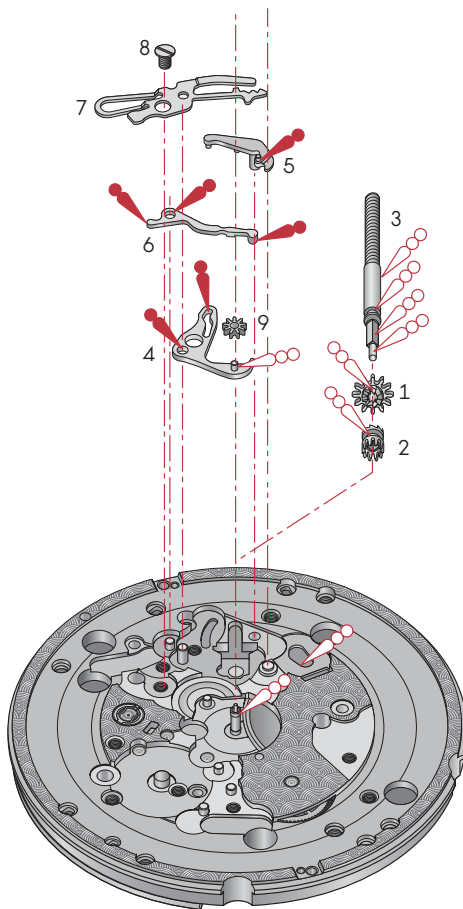

 Moebius SYNT HP-1300 Sans Colorant
 Moebius 9504



Exploded views - Movement side for Calibre 2628

Parts listed in order of assembly

1 = 1004107	14 = 30039
2 = 32033	15 = 30025
3 = 31023	16 = 30027*
4 = 31024	17 = 1004807
5 = 31021	18 = 3505 (1x)
6 = 51120	19 = 30040
7 = 81036	20 = 40010
8 = 3509 (1x)	21 = 1005707
9 = 30012	22 = 3511 (1x)
10 = 20010	23 = 3511 (1x)
11 = 31020	24 = 10058°
12 = 1004107	4005021
13 = 3503 (3x)	

-  Moebius SYNT-A-LUBE 9010
-  Moebius SYNT HP-1300 Sans Colorant
-  Moebius SYNT HP-500
-  Moebius SYNT HP-1300 Sans Colorant
-  Kluber P125

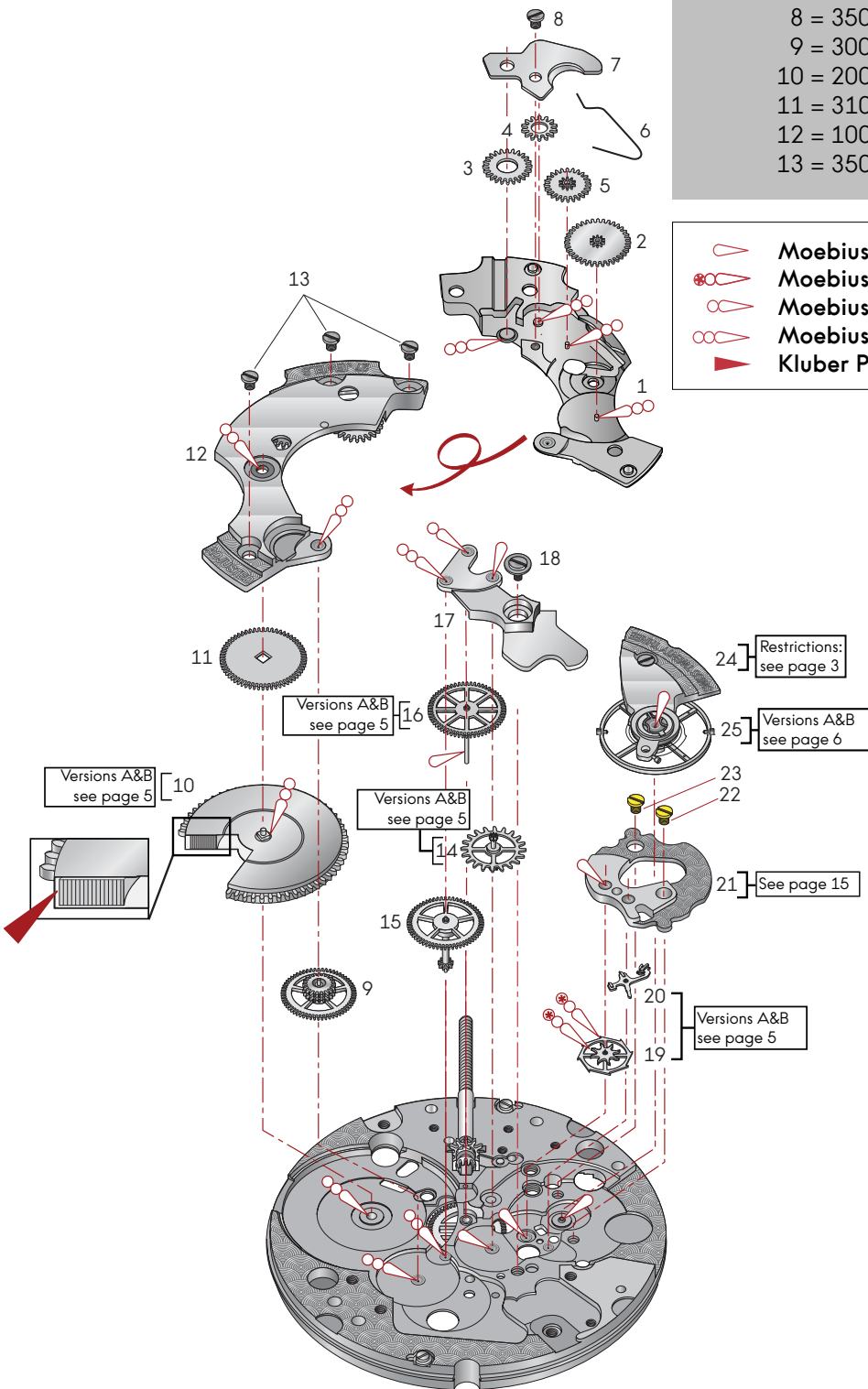

Exploded views - Movement side for Calibre 2628

Parts listed in order of assembly

1 = 56070	8 = 3504 (1x)
2 = 1203007	9 = 2201006
3 = 32032	10 = 3507 (3x)
4 = 32031	11 = 3503 (3x)
5 = 32037	12 = 52041
6 = 52040	13 = 12124
7 = 1205107	14 = 3506 (1x)

⦿ See CS-Info Calibre no. 26 **Lubeta V105**
When Lubeta V105 is available, do not use Moebius 9010

⦿ **Moebius SYNT-A-LUBE 9010**
⦿ **Moebius SYNT HP-1300 Sans Colorant**

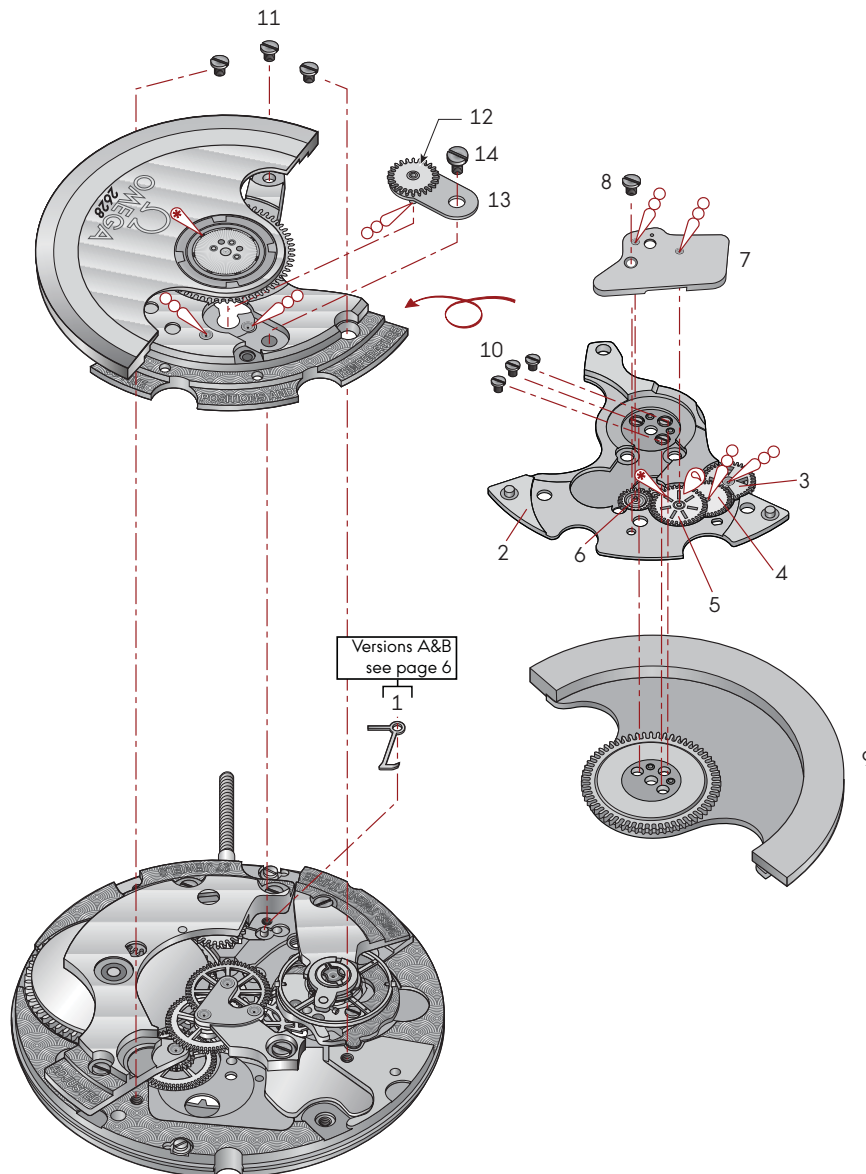



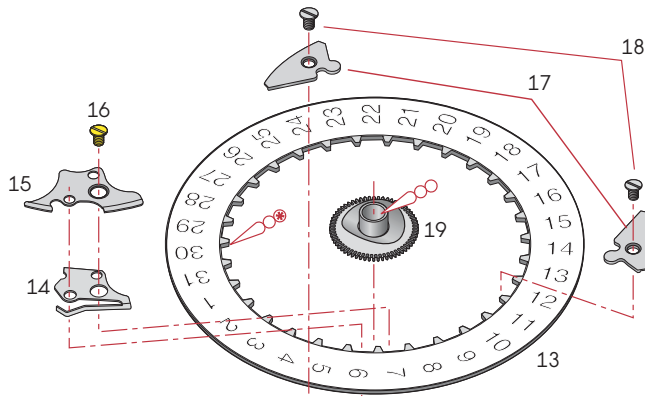

Exploded views - Dial side for Calibre 2628

Parts listed in order of assembly

1 = 31083*	11 = 1601006
2 = 31041	12 = 3502 (3x)
3 = 31100	13 = 91440
4 = 31101	14 = 53080
5 = 10062	15 = 13111
6 = 3503 (1x)	16 = 3501 (1x)
7 = 31101	17 = 13105 (2x)
8 = 33032	18 = 3500 (2x)
9 = 31046*	19 = 3104706*
10 = 33014	



-  **Moebius 9010**
-  **Moebius SYNT HP-1300 Sans Colorant**
-  **Moebius SYNT HP-1300 Sans Colorant**
-  **Moebius 9504**

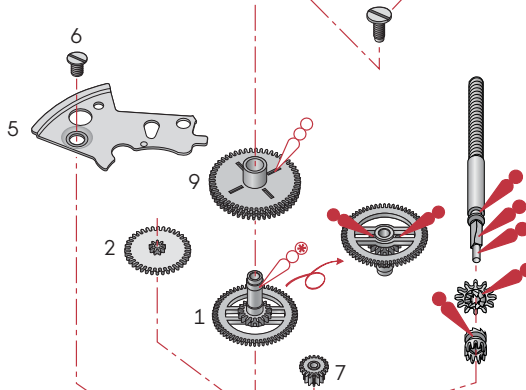
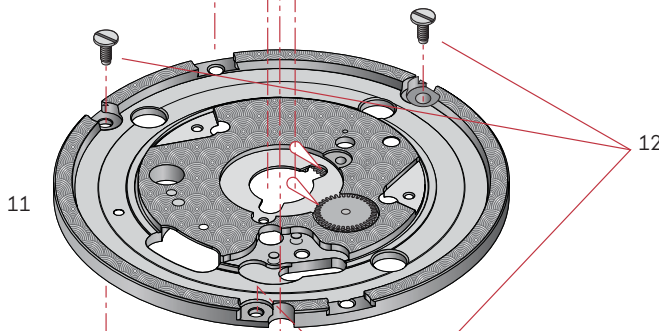





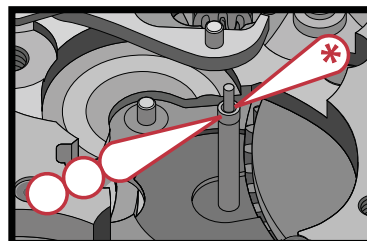



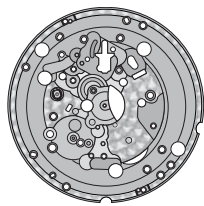

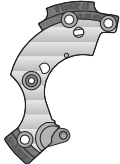

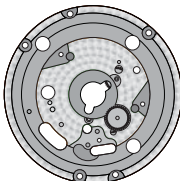

Additional lubrication:
See CS-Info Calibre no. 32





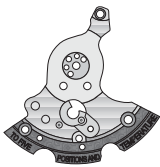
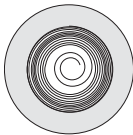



















Lubrication spot (Moebius 9010, small quantity)
at the exit of the second wheel axle - centre tube.





























Spare parts list for Calibre 2628

Main plate, pre-assembled	Version	Reference	Reverser maintaining plate	Version	Reference
	2628A	72226281002007		2628A	722112012124
	2628B	7222628B1002007		2628B	
Barrel bridge	Version	Reference	Date indicator maintaining plate	Version	Reference
	2628A	7222500B1004107		2628A	722112813105
	2628B			2628B	
Wheel train bridge	Version	Reference	Date jumper maintaining plate	Version	Reference
	2628A	7222500B1004807		2628A	722112813111
	2628B			2628B	
Pallet bridge, pre-assembled	Version	Reference	Display mechanism platform, assembled	Version	Reference
	2628A	72225001005707		2628A	72226281601006
	2628B			2628B	
Balance bridge	Version	Reference	Barrel complete	Version	Reference
	2628A	7222500B1005824		2628A	7222500B20010
	2628B	7222500C1005824		2628B	722112020010
Minute train bridge	Version	Reference	Barrel drum and cover	Version	Reference
	2628A	722112810062		2628A	722112020030
	2628B			2628B	
Dial fastener	Version	Reference	Barrel arbor	Version	Reference
	2628A	722112010300		2628A	722112020060
	2628B			2628B	
Upper automatic bridge	Version	Reference	Mainspring	Version	Reference
	2628A	7222500B1203007		2628A	7222500B20102
	2628B			2628B	722112020102
Lower automatic bridge	Version	Reference	Oscillating weight, assembled	Version	Reference
	2628A	72211201205107		2628A	72226282201006
	2628B			2628B	7222628B2201006

Spare parts list for Calibre 2628

Ball bearing	Version	Reference	Hour wheel	Version	Reference
	2628A	722112022040		2628A	722112831046*
	2628B			2628B	
Oscillating weight bolt	Version	Reference	Hour wheel, 24 hours	Version	Reference
	2628A	722112022042		2628A	72211203104706*
	2628B			2628B	
Intermediate wheel	Version	Reference	Cannon pinion with driving wheel	Version	Reference
	2628A	722112030012		2628A	722112831083*
	2628B			2628B	
Third wheel	Version	Reference	Setting wheel	Version	Reference
	2628A	722112030025		2628A	722112831100
	2628B			2628B	
Second wheel	Version	Reference	Intermediate setting wheel	Version	Reference
	2628A	722112830027*		2628A	722112831101
	2628B	7222628B30027*		2628B	
Intermediate escape wheel	Version	Reference	Winding pinion	Version	Reference
	2628A	7222500B30039		2628A	722112831120
	2628B	7222500C30039		2628B	
Co-Axial wheel	Version	Reference	Sliding pinion	Version	Reference
	2628A	7222500B30040		2628A	722112831121
	2628B	7222500C30040		2628B	
Ratchet wheel	Version	Reference	Reduction wheel	Version	Reference
	2628A	722112031020		2628A	722112032031
	2628B			2628B	
Intermediate ratchet wheel	Version	Reference	Intermediate reduction wheel	Version	Reference
	2628A	722112031021		2628A	722112032032
	2628B			2628B	
Crown wheel	Version	Reference	Ratchet wheel driving wheel	Version	Reference
	2628A	722112031023		2628A	722112032033
	2628B			2628B	
Intermediate crown wheel	Version	Reference	Reversing wheel	Version	Reference
	2628A	722112031024		2628A	722112032037
	2628B			2628B	
Minute wheel	Version	Reference	Intermediate date wheel	Version	Reference
	2628A	722112831041		2628A	722112833014
	2628B			2628B	

Spare parts list for Calibre 2628

Date wheel	Version	Reference	Stop lever	Version	Reference
	2628A	722112833032		2628A	722250056070
	2628B			2628B	7222500C56070
Pallet fork	Version	Reference	Shock-absorber, upper	Version	Reference
	2628A	7222500B40010		2628A	722112070530
	2628B	7222500C40010		2628B	7222500C70530
Balance complete with stud	Version	Reference	Shock-absorber, lower	Version	Reference
	2628A	7222500B4005021		2628A	722112070640
	2628B	7222500C4005021		2628B	7222500C70640
Stud support	Version	Reference	In settings, upper	Version	Reference
	2628A	7222500B40200		2628A	722112070531
	2628B			2628B	7222500C70531
Winding stem	Version	Reference	In settings, lower	Version	Reference
	2628A	72211285101021		2628A	722112070641
	2628B			2628B	7222500C70641
Yoke	Version	Reference	Cap jewel, upper	Version	Reference
	2628A	722112051050		2628A	722112070900
	2628B			2628B	
Setting lever	Version	Reference	Cap jewel, lower	Version	Reference
	2628A	72211285108006		2628A	722112070901
	2628B			2628B	
Setting lever jumper	Version	Reference	Shock-absorber spring, upper	Version	Reference
	2628A	722112051091		2628A	722112078004
	2628B			2628B	
Click	Version	Reference	Shock-absorber spring, lower	Version	Reference
	2628A	722112051120		2628A	722112078005
	2628B			2628B	
Reverser	Version	Reference	Centre tube	Version	Reference
	2628A	722112052040		2628A	722112880400
	2628B			2628B	
Auxiliary reverser	Version	Reference	Click plate	Version	Reference
	2628A	722112052041		2628A	722112081036
	2628B			2628B	
Date corrector operating lever	Version	Reference	Date indicator	Version	Reference
	2628A	722112853022		2628A	722262891440*
	2628B			2628B	
Date jumper	Version	Reference	Screw for date indicator maintaining plate	Version	Reference
	2628A	722262853080		2628A	72211283500
	2628B			2628B	

Spare parts list for Calibre 2628















Screw for date jumper maintaining plate	Version	Reference
	2628A	72211283501
	2628B	
Screw for display mechanism platform	Version	Reference
	2628A	72211283502
	2628B	
Screw for setting lever jumper	Version	Reference
	2628A	72211203503
	2628B	
Screw for minute train bridge	Version	Reference
	2628A	72211203503
	2628B	
Screw for automatic device	Version	Reference
	2628A	72211203503
	2628B	
Screw for barrel bridge	Version	Reference
	2628A	72211203503
	2628B	
Screw for balance bridge	Version	Reference
	2628A	72211203503
	2628B	
Screw for lower automatic device bridge	Version	Reference
	2628A	72211203504
	2628B	
Screw for wheel train bridge	Version	Reference
	2628A	72211203505
	2628B	
Screw for reverser maintaining plate	Version	Reference
	2628A	72211203506
	2628B	
Screw for ball bearing	Version	Reference
	2628A	72211203507
	2628B	
Screw for click plate	Version	Reference
	2628A	72211203509
	2628B	
Screw for pallet bridge	Version	Reference
	2628A	72225003511
	2628B	
Screw for stud	Version	Reference
	2628A	72225003512
	2628B	



Fig. 1.0

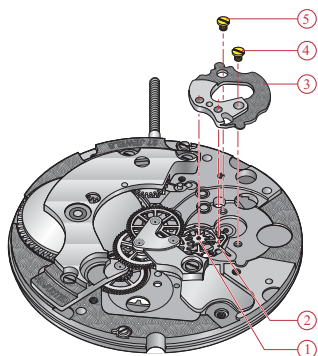

1.0 Assembling of the escapement system

Key points

The order of assembly must be respected (See page 11). After assembling, the escapement functions must be checked accurately with the corresponding tool.

The pallet bridge positions the co-axial wheel and the pallet fork. To ensure the functioning of the escapement it is necessary to respect the following order of assembly:

1. Position the co-axial wheel.
2. Position the pallet fork.
3. Position the pallet bridge, screw no (4) must be correctly placed in their beds.
4. To position the pallet bridge, screw no (4) must be fixed first.
5. The second screw (5) fixes the bridge.

Fig. 2.1

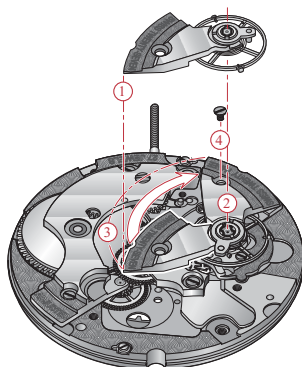

2.1 Assembling of the balance bridge

As the table roller is under the pallet fork, the balance must be assembled carefully.

1. Position the complete balance bridge (with balance). The bridge is pointing towards the center of the movement.
2. Check the position of the balance. The pivot of the balance-staff must be correctly placed in its bed.
3. Carefully turn the bridge to its normal position.
4. Fix the bridge with its screw.

Fig. 2.2

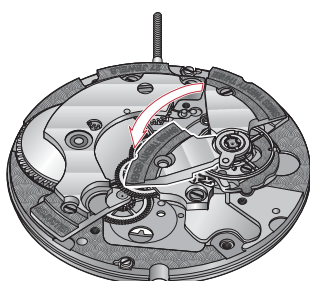

2.2 Disassembling of the balance bridge

The balance bridge must be disassembled by removing the parts in the opposite order of procedure 2.2. To avoid any risk of damaging the balance, the bridge has to be turned towards the center of the movement. In this position the bridge may be removed without any risk.

3.0 Runners for hand setting and hand setting force

Description	Movement holder	Nbr. of runners for hand setting	Minimum force (N)	Maximum force (N)	Support (jewel)
GMT hand	507 0017	7	10	50	no
Hour hand		5	10	50	no
Minute hand		2	10	30	no
Second hand		1	10	30	yes

3.2 Height of hands







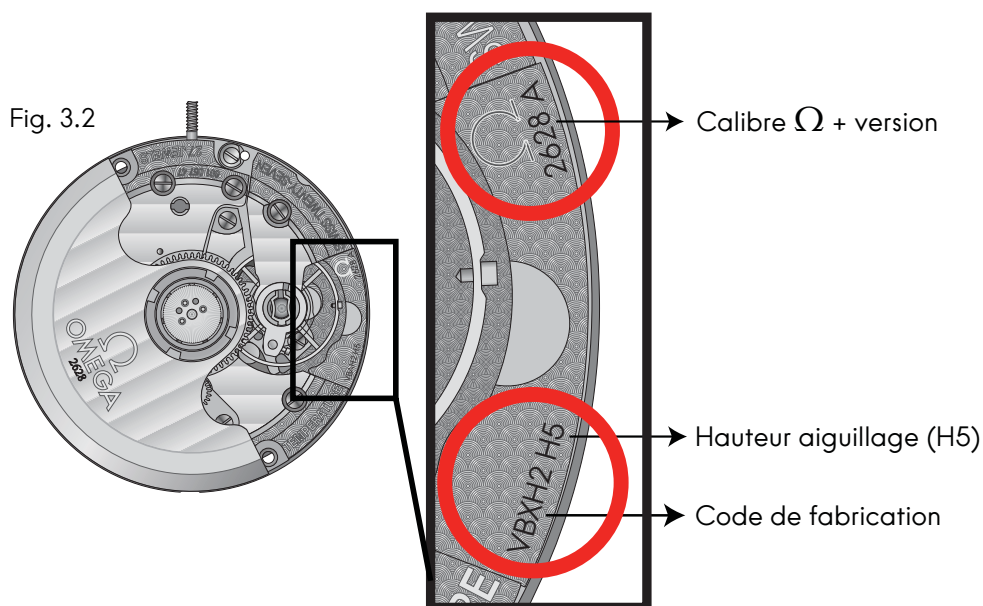

The star next to a supply reference in the part list means that there are several heights of hands.
e.g.: 722112831083*.

To order movement parts, you must enter the order as follows:
e.g. : 7221128310835.

The last figure indicates the wheel height.



4.0 Components that must not be epilam-treated after cleaning

Description	Reference	
Balance assembled on the balance bridge *	40055 + 10058°	
Complete balance	40055	
Pallet fork	40010	
In-setting, upper *	70640	
In-setting, lower *	70641	
Pallet fork bridge	1005707	
Barrel complete**	20010	
Mainspring	20102	
Reversing wheel	32037	

* Do not treat the shock-absorber settings with epilam; the cap jewels should however be treated
 ** Do not treat the complete barrel with epilam, only the drum, cover and arbour separately.

Demagnetise the movement according to Working Instruction 34.

Values to be checked

Please consult Working Instructions 5 and 28 for instructions and tolerances.

Special parameter settings

Instrument type	Co-Axial 4 Hz calibres	Co-Axial 3.5 Hz calibres	Comments
Former Witschi instruments - Watch Expert (red case) - Wicometer Professional - Chronoscope M1 (old version)	Lift angle set to 30°	Lift angle set to 38°	3.5 Hz calibres: The frequency parameters (25'200 A/h) should be set manually so that the instantaneous rate is
	All measurements are correct	The amplitude is not measured correctly	
New Witschi instruments - Watch Expert II (white case) - Chronoscope M1 (up-dated version) - Chronoscope S1	Lift angle set to 38°	Lift angle set to 38°	Test mode: Parameters must be set for «Spe1»!
	All measurements are correct	All measurements are correct	

Fig. 5.0

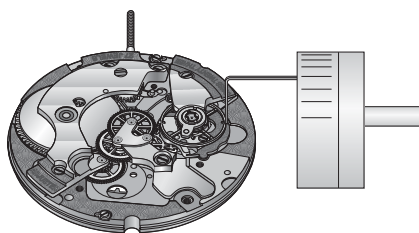
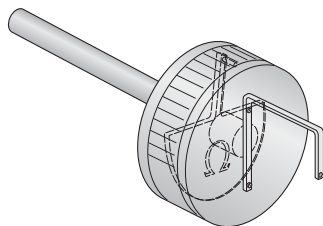
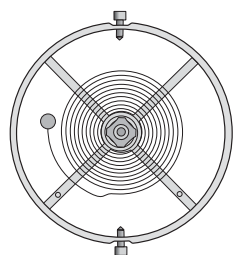

Fig. 5.1



REF. 506 0042

Fig. 5.2



5.0 Timing key

A special timing key tool has been developed to adjust the rate even when the movement is cased in. The rate can be corrected according to the table below by turning the two balance screws a complete turn. A scale is found on the outside of the tool. A division corresponds to a rate correction of 1 second. (according to the table below). One screw is located between two arms on the balance which are specially marked by points (see Figure 5.2) for easy identification of each screw during the correction process.

Balance

The annular balance has two adjusting micro-screws. A slow rate deviation is corrected by tightening the micro-screws (towards the centre of the balance), which reduces its moment of inertia and makes it run faster. A fast rate deviation is corrected by loosening the micro-screws (away from the centre of the balance). This increases its moment of inertia and makes it run slower.

Important:

The rate is always corrected using **both adjustment screws** to prevent an unbalance of the balance.

Version A	Version B
One correction turn = 57 seconds	One correction turn = 86 seconds
One division = 1 second	One division = 1.5 seconds

